

SONY

VPL-GTZ380

The world's most advanced compact
4K SXRD™ 10,000lm Laser Projector



SXRD

X1
for projector

Z-Phosphor
LASER LIGHT SOURCE

At a glance

- Native 4K resolution: 4096x2160
- 10,000 ANSI lumens
- Infinite dynamic contrast
- 100% DCI-P3 with no brightness loss
- 'X1 Ultimate for Projector' advanced picture processing
- Object based HDR remaster
- Object based Super Resolution for industry leading image clarity
- Digital Contrast Optimizer for inky blacks and shadow detail

The Sony VPL-GTZ380 is the world's most advanced projector designed for large home cinemas to bring a true theater experience home. An exceptional 10,000 lumens of brightness with 100% DCI-P3 wide color gamut is perfect for the largest and most lavishly equipped home cinema rooms and well-lit living spaces alike. The VPL-GTZ380 brings movies to life with strikingly expressive images that deliver an unforgettable viewing experience, for whatever you're watching.

Laser light source

The VPL-GTZ380 has a brand new laser light source design that includes an additional red diode. This enables the projector to achieve 100% DCI-P3 colour space without the need for colour filtering resulting in no brightness loss when using DCI-P3.

Dynamic HDR Enhancer

Deliver the optimal projected HDR experience through Sony's advanced scene by scene HDR processing. Achieve striking highlights whilst maintaining deep black levels.

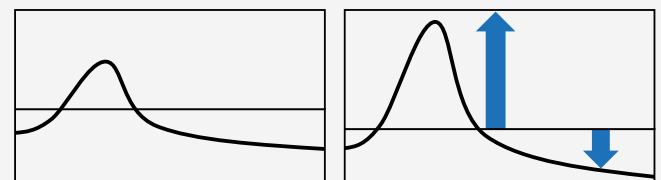
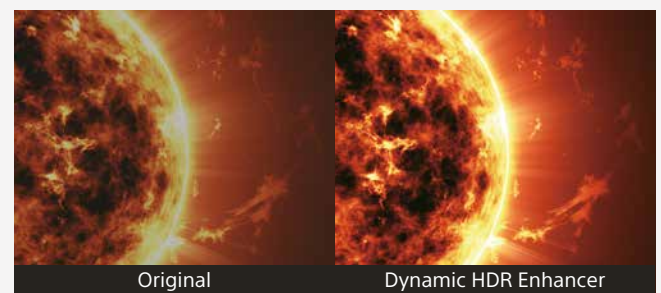

Native 4K SXRDTM panel

Sony's advanced SXRDTM (Silicon X-tal Reflective Display) panel technology featured in Sony's digital cinema projectors delivers native 4K (4096 x 2160) resolution images, with more than four times the detail of Full HD. Fine details are wonderfully clear and natural, without jagged edges or visible pixels.



Native 4K Panel
4096 x 2160
(8.8 million pixels)

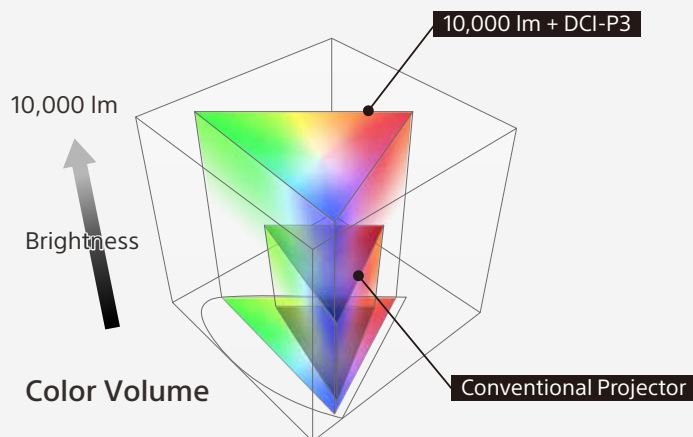

DCI-P3 is 100% covered
DCI-P3 is 1.35x wider
than sRGB

Dual Database Processing

Two powerful image improvement databases work together to dynamically improve pixels in real-time for image clarity.

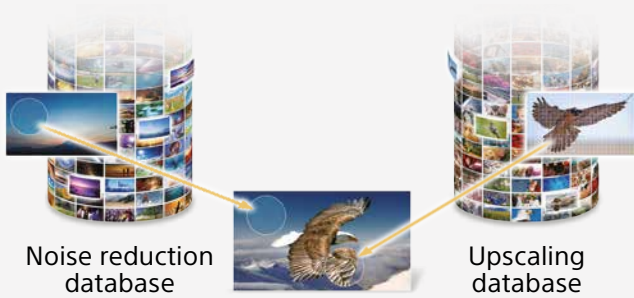

Digital Contrast Optimizer

The image contrast is optimized by analyzing each scene in advance to deliver inky blacks and superb shadow details.



Object-based Super Resolution

Hundreds of objects are identified and their resolution is individually enhanced to give a picture of exceptional accuracy and detail.

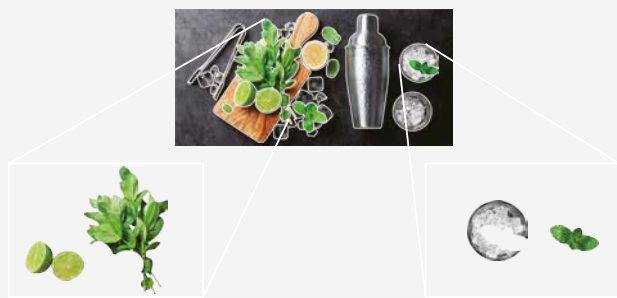

Object-based HDR Remaster

Individual objects on screen are analyzed and the contrast adjusted, to reproduce greater depth and textures, and more realistic pictures.



Specifications

		VPL-GTZ380
Display system		4K SXRD panel, projection system
Display device	Size of effective display area	0.74" x 3
	Number of pixels	26,542,080 (4096 x 2160 x 3) pixels
Projection lens	Focus	Powered
	Zoom	Powered
	Lens shift	VPLL-Z8014 (Optional) : Powered, Vertical: +/-80 %, Horizontal: +/-33 %
		VPLL-Z8008 (Optional) : Powered, Vertical: +/-50 %, Horizontal: +/-19 %
Throw ratio*1		VPLL-Z8014 (Optional) : 1.49 : 1 to 2.91 : 1
		VPLL-Z8008 (Optional) : 0.85 : 1 to 1.09 : 1
Light source		Laser diode
Recommended lamp replacement time*2		-
Light output		10,000 lm
Dynamic contrast		∞ : 1
Accepted digital signals		720 x 576/50p, 720 x 480/60p, 1280 x 720/50p, 1280 x 720/60p, 1920 x 1080/50i, 1920 x 1080/60i, 1920 x 1080/24p, 1920 x 1080/50p, 1920 x 1080/60p, 1920 x 1080/120p, 1920 x 1080/100p, 3840 x 2160/24p, 3840 x 2160/25p, 3840 x 2160/30p, 3840 x 2160/50p, 3840 x 2160/60p, 4096 x 2160/24p, 4096 x 2160/25p, 4096 x 2160/30p, 4096 x 2160/50p, 4096 x 2160/60p, WUXGA/60p, QXGA/60p, QXGA/120p, WQHD/60p, WQHD/120p, WQXGA/60p, WQXGA/120p
Input Output (Computer / Video / Control)	HDMI	x 2 (HDCP2.3)
	Display Port	x 2 (HDCP2.3)
	Trigger	x 2 (Mini jack, DC 12 V, Max. 100 mA)
	RS-232C	x 1 (D-sub 9-pin (male))
	LAN	x 1 (RJ-45, 10BASE-T/100BASE-TX)
	IR IN / OUT	IN: x 1, Out: x 1 (Mini jack)
	3D SYNC OUT	x 1 (3-pin mini-DIN (VESA 3D))
USB	x 1 (Type A, DC 5 V, Max. 500 mA)	
Picture processor		X1 Ultimate for projector
Object-based HDR remaster		Yes
Dynamic HDR Enhancer		Yes
Object-based Super Resolution		Yes
Super Resolution		-
Dual database processing		Yes
Digital Contrast Optimizer		Yes
Digital Focus Optimizer		Yes
Dynamic contrast control		Dynamic laser control
Motionflow		Yes
HDR Format		HDR10/HLG
3D		Yes
Picture position memory		5
Input lag reduction		Yes (4K/2K)
Acoustic noise*3		33-39 dB
Power requirements		AC 200-240 V, 50/60 Hz, AC 100-120 V, 50/60 Hz (Brightness is dimmed.)
		Max. 2.0 kW (TBD)
		0.4 W (when "Remote Start" is set to "Off")
Power consumption	Standby	1.0 W (LAN) (when "Remote Start" is set to "On")
	Networked Standby	
Dimensions (Without Protrusions)		W 560 x H 228 x D 760 mm (W 22 1/16 x H 8 31/32 x D 29 15/16 in)
Mass		Approx. 51 kg / 112 lb.
Supplied accessories		RM-PJ29 Remote Commander (1), Size AA (R6) Manganese Batteries (2), AC power Cord (1), Lens Cap (1), Plug holder (1), Safety Regulations (1)
Optional accessories		VPLL-Z8014 (Normal throw lens) VPLL-Z8008 (Short throw lens)

*1 Display size : 16:9

*2 The figures are expected maintenance time and not guaranteed. They will depend on the environment or how the projector is used.

*3 Depends on the projector setting condition and usage environment.

© 2020 Sony Corporation.

All rights reserved. Reproduction in whole or in part without permission is prohibited. Features and specifications are subject to change without notice. All non-metric weights and measurements are approximate. 'Sony' is a registered trademark of Sony Corporation. All other trademarks are the property of their respective owners.

Errors and omissions excepted.

www.pro.sony @SonyDisplays

Follow us on 



Dimensions

CONNECTOR PANELS

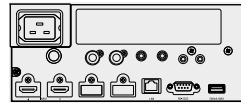

Front

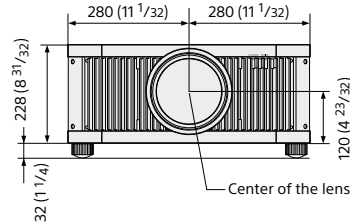

Bottom

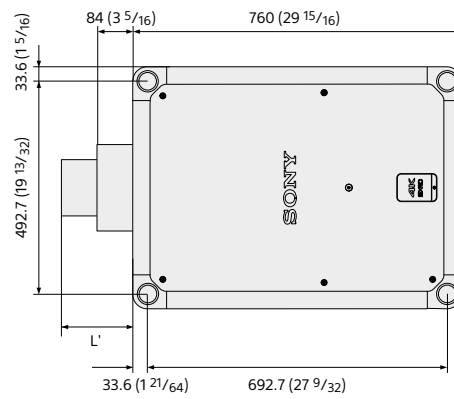

Optional Accessories



X105-RF-X1
XpanD 3D Glasses



XpanD AE125 RF PRO
3D Transmitter

Optional Lenses

Optional Lenses	VPLL-Z8008	VPLL-Z8014
Throw Ratio	0.8-1.02	1.4-2.73
F-number	2.9	2.9 (wide) - 3.2 (Tele)
Supported screen size (inch)	60-1,200	60-600
Zoom		Powered
Focus		Powered
Lens shift Range - V	+/- 50%	+/- 80%
Lens shift Range - H	+/- 18%	+/- 31%
Iris		None
Dimensions (W x H x D)	141 x 170 x 306 mm (5 9/16 x 6 11/16 x 12 1/16 in)	141 x 170 x 297 mm (5 9/16 x 6 11/16 x 11 11/16 in)
Weight (kg/lb)	4.1 kg / 9 lb	3.8 kg / 8.4 lb