

O N K Y O

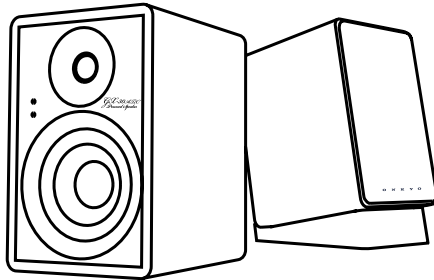

CREATOR SERIES

Instruction Manual

POWERED SPEAKER
GX-30ARC

En

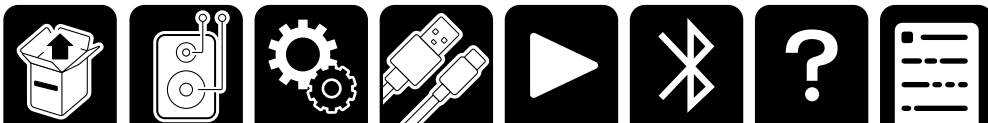

What's in the box

①

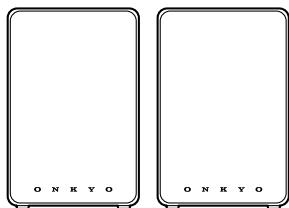

④

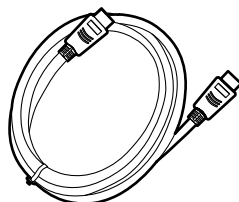

⑦

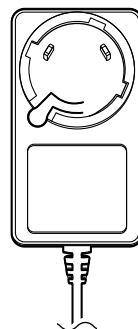

②



⑤

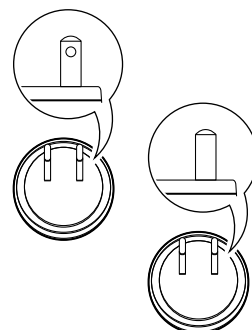
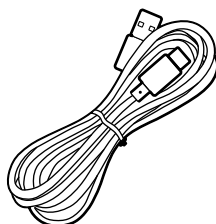

③

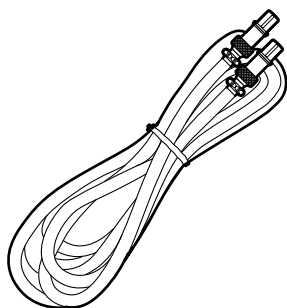

⑥

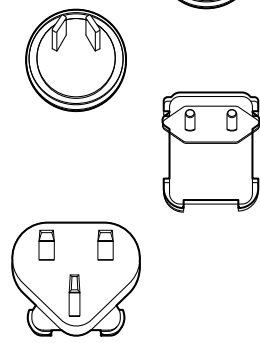
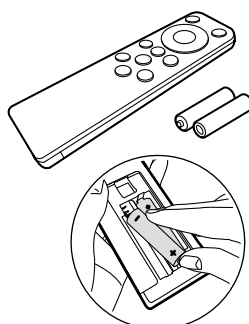

- ① **Speakers (2)**
- ② **Speaker stands (2)**
- ③ **Speaker cable (1)**
- ④ **HDMI cable (1)**
- ⑤ **USB cable (1)**
- ⑥ **Remote controller (RC-993S) (1)**
*Batteries (AAA/R03) (2)
- ⑦ **AC adapter and plug adapter**
 - Initial Setup Guide (1)
 - Safety Information (1)
 - Warranty: For North America (1) and Europe (1)

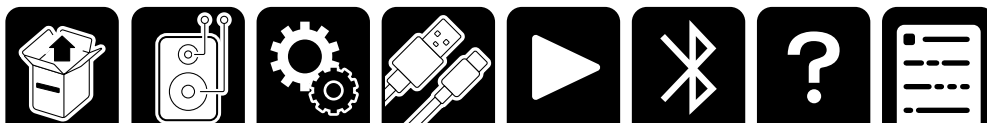

Part Names

Front Panel

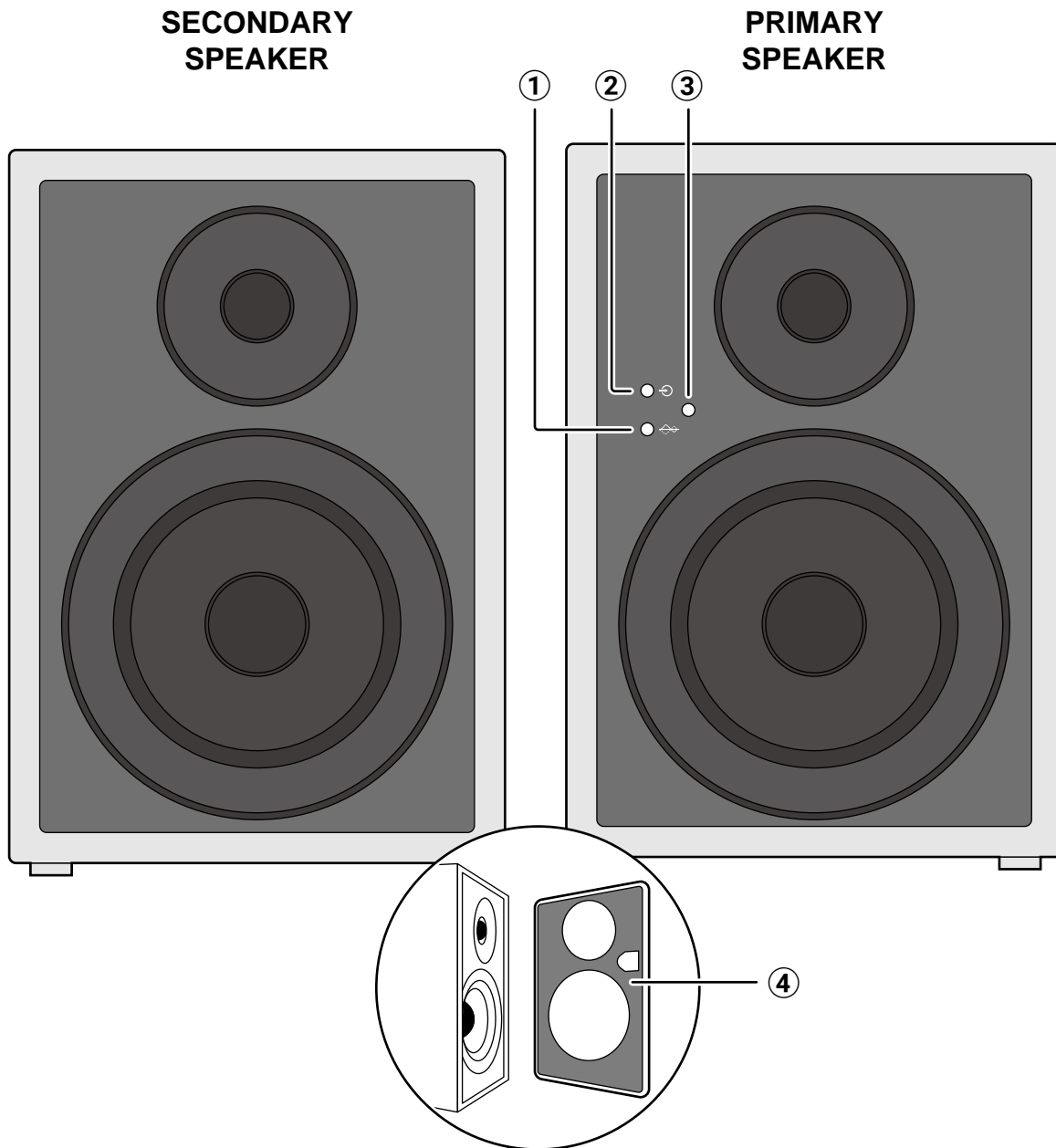

- ① LED Flat sound mode Indicator
- ② LED Source Indicator
- ③ Remote control sensor
- ④ Speaker grill

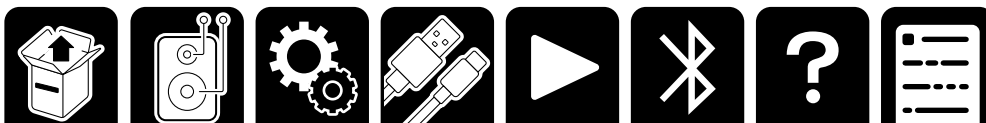

Rear Panel

SECONDARY SPEAKER

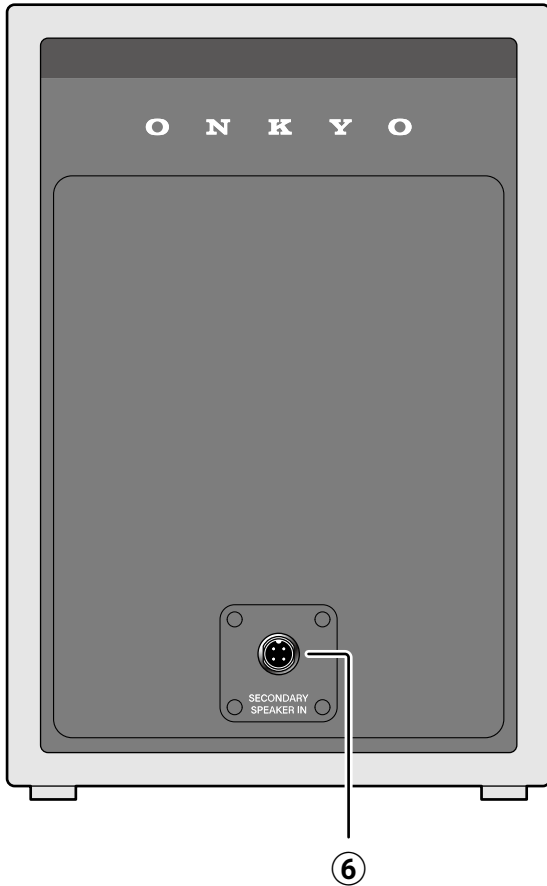

PRIMARY SPEAKER

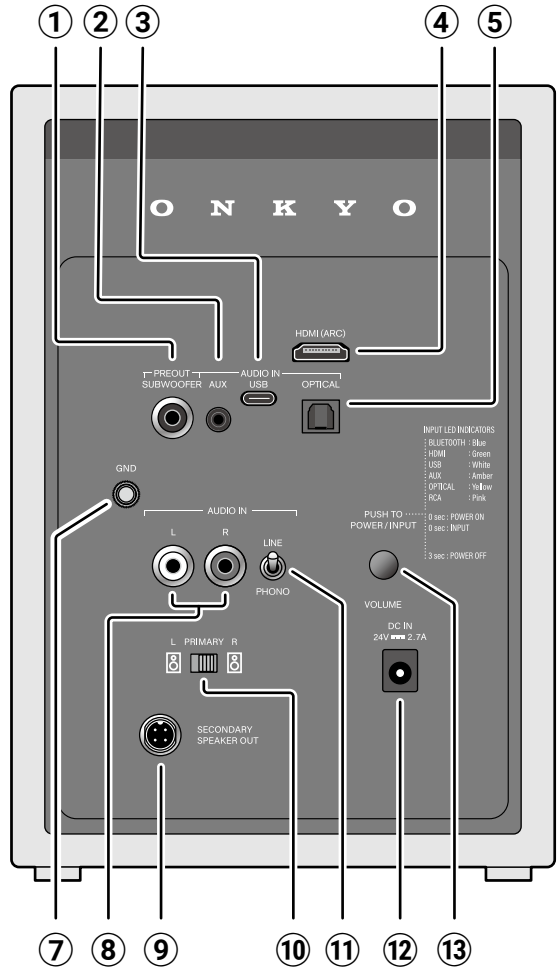

- ① PREOUT SUBWOOFER terminal
 - ② AUDIO IN AUX terminal (ϕ 3.5mm stereo mini plug terminal)
 - ③ USB Type-C terminal
 - ④ HDMI terminal
 - ⑤ Optical digital input terminal
 - ⑥ Speaker terminal (SECONDARY)
 - ⑦ GND terminal
 - ⑧ AUDIO IN LR terminals (RCA stereo terminals)
 - ⑨ Speaker terminal (PRIMARY)
 - ⑩ L/R selector switch
 - ⑪ LINE/PHONO selector switch
 - ⑫ DC IN terminal
 - ⑬ POWER/INPUT switch
- VOLUME dial

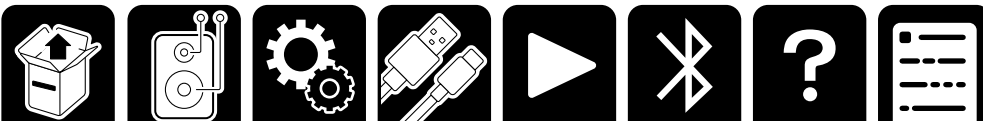

Remote Controller

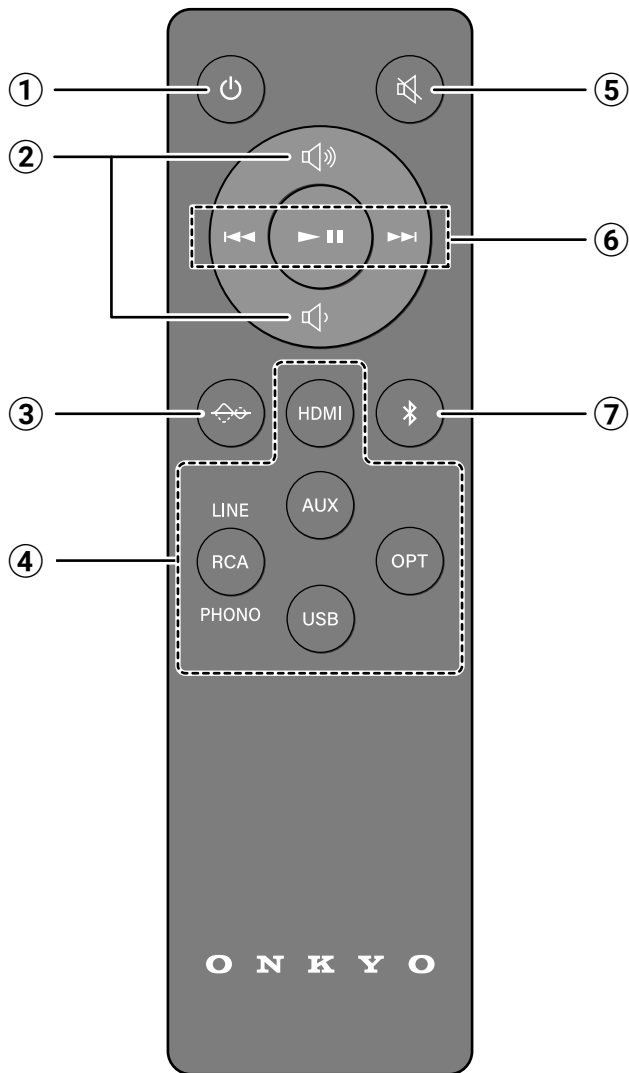

- ① ON/STANDBY button
- ② Volume UP/DOWN buttons
- ③ Flat sound mode button
- ④ Input selector buttons
- ⑤ Mute button
- ⑥ Play operation buttons
- ⑦ BLUETOOTH® button

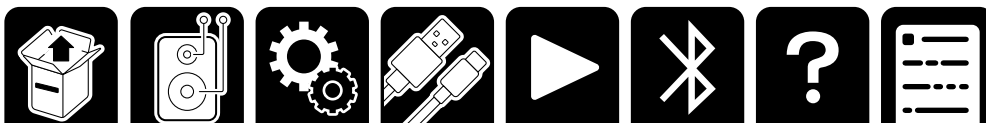

Setup

■ Connecting the speaker cable

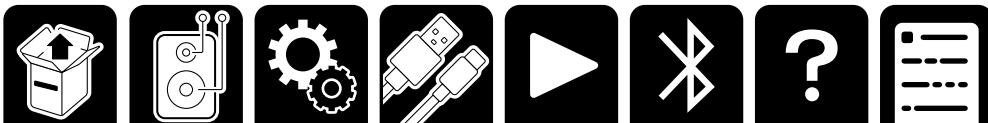
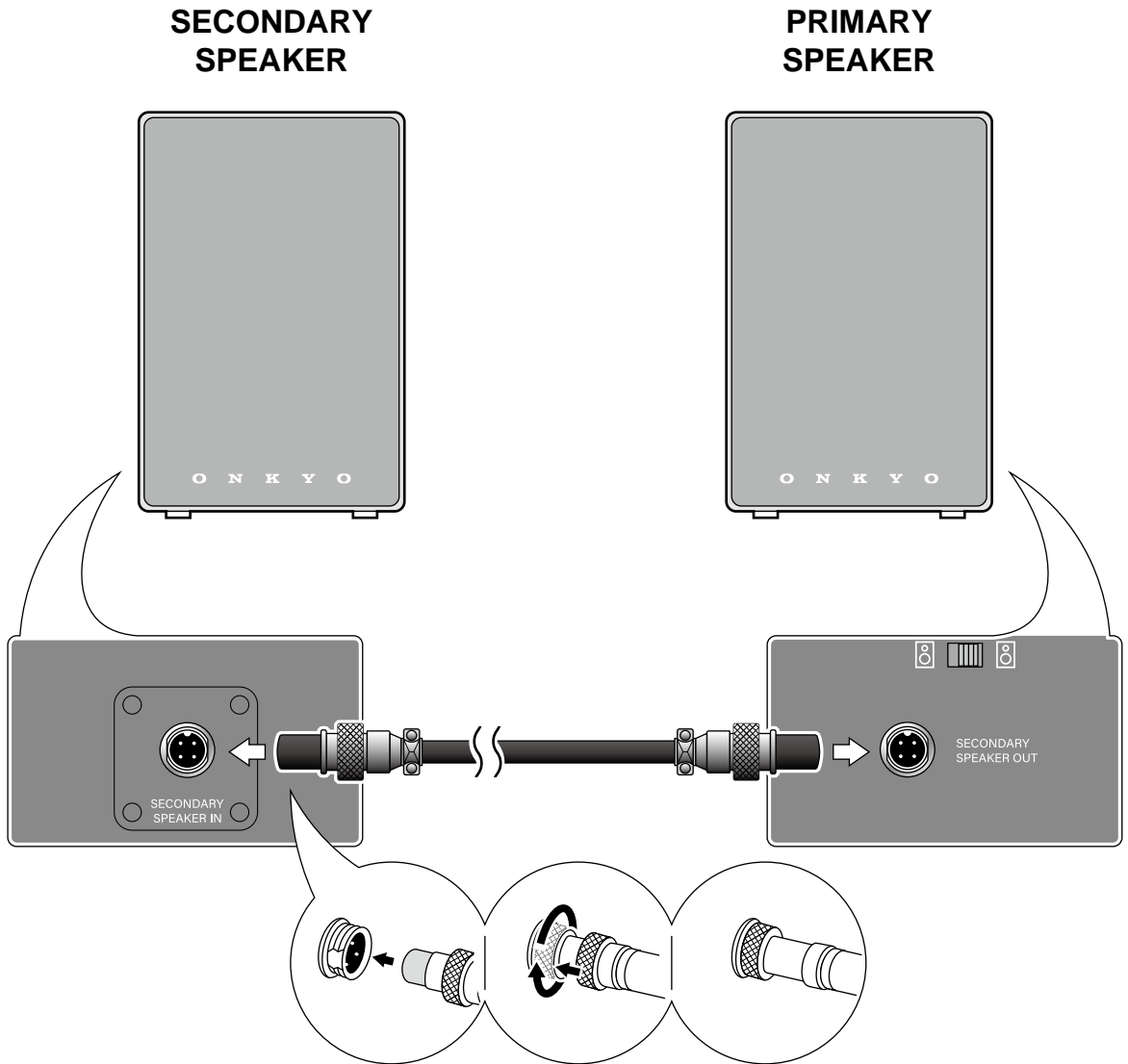

■ Assembling and connecting the AC adapter

1

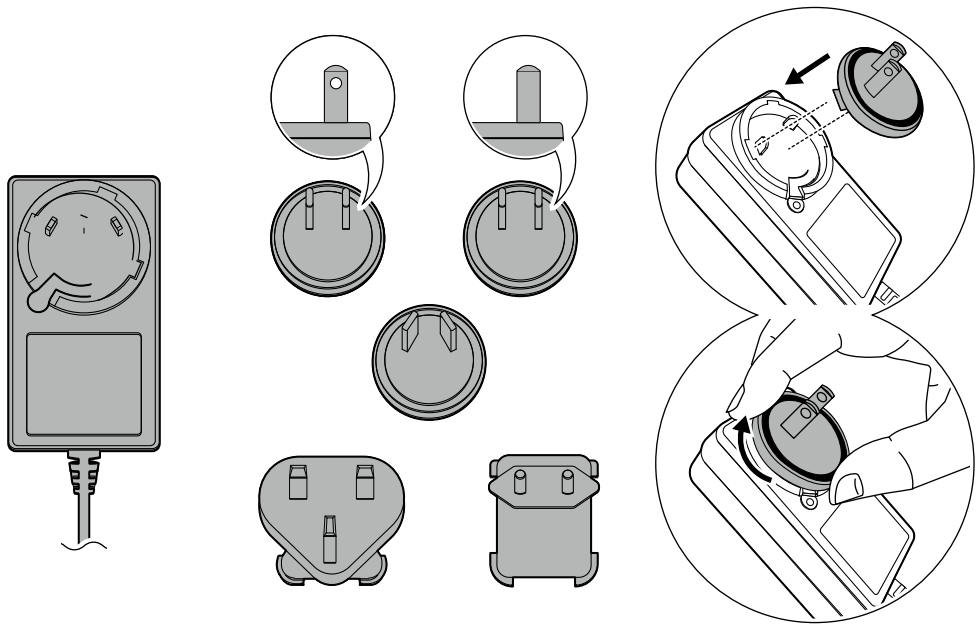

2

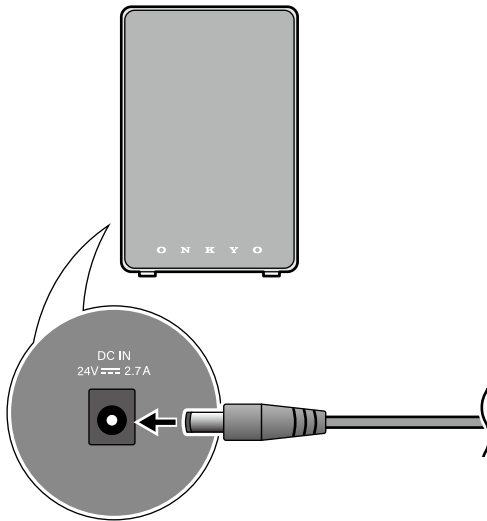

3

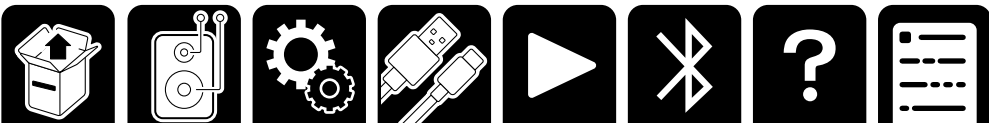
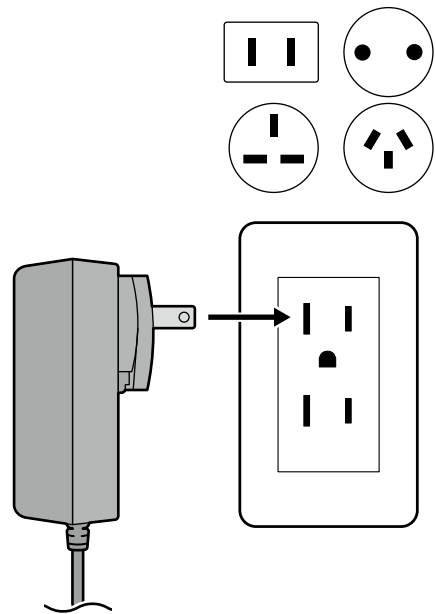

Connections

Connecting a PC

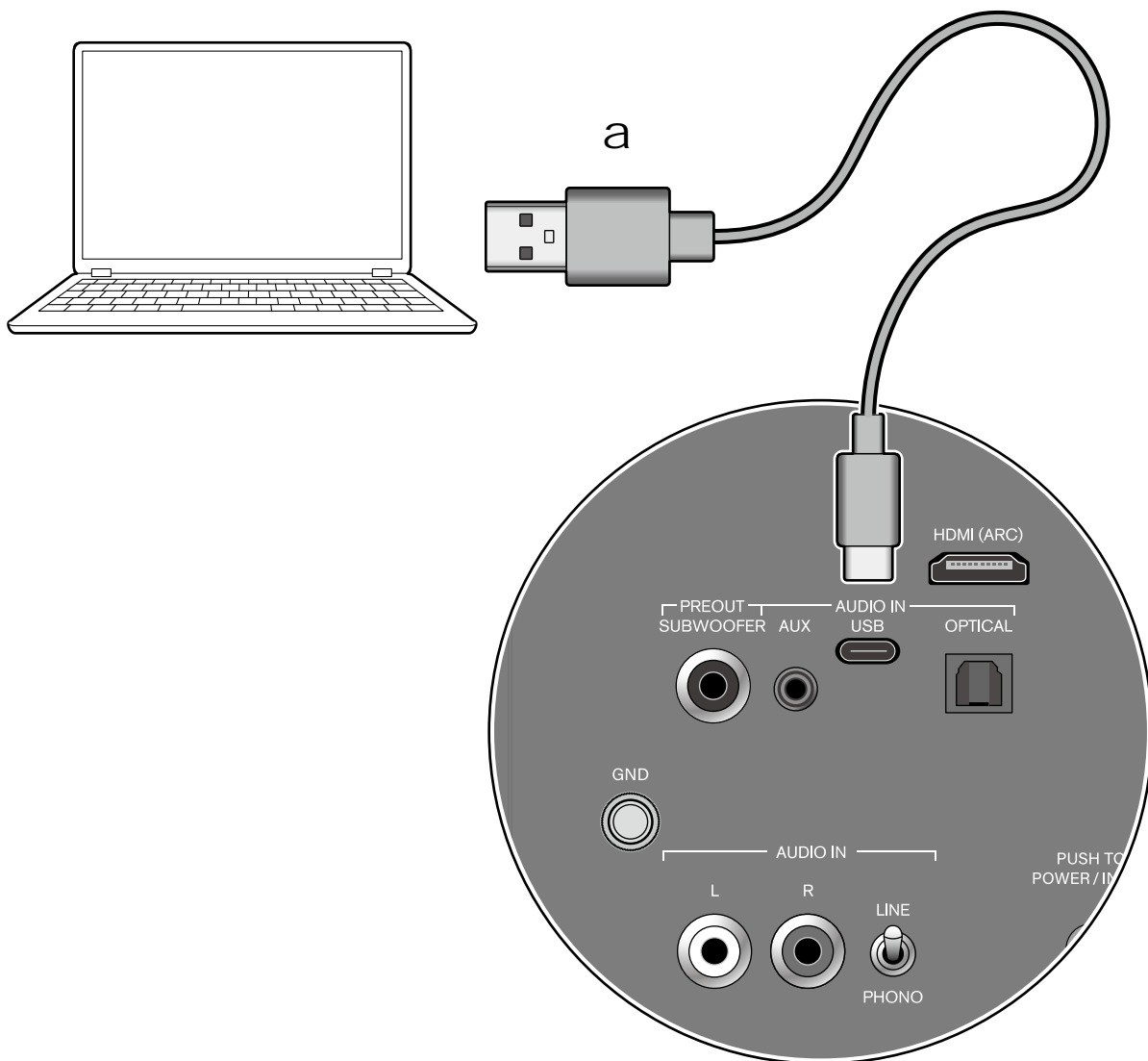

a USB cable

*A USB storage device can be connected directly.

Connection location

This unit: AUDIO IN USB terminal (USB Type-C terminal)

Tips

Supported OS: Windows10 or later

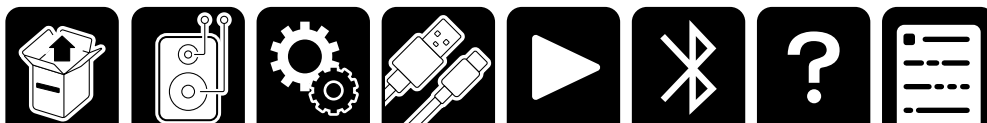

Connecting an ARC-supported TV

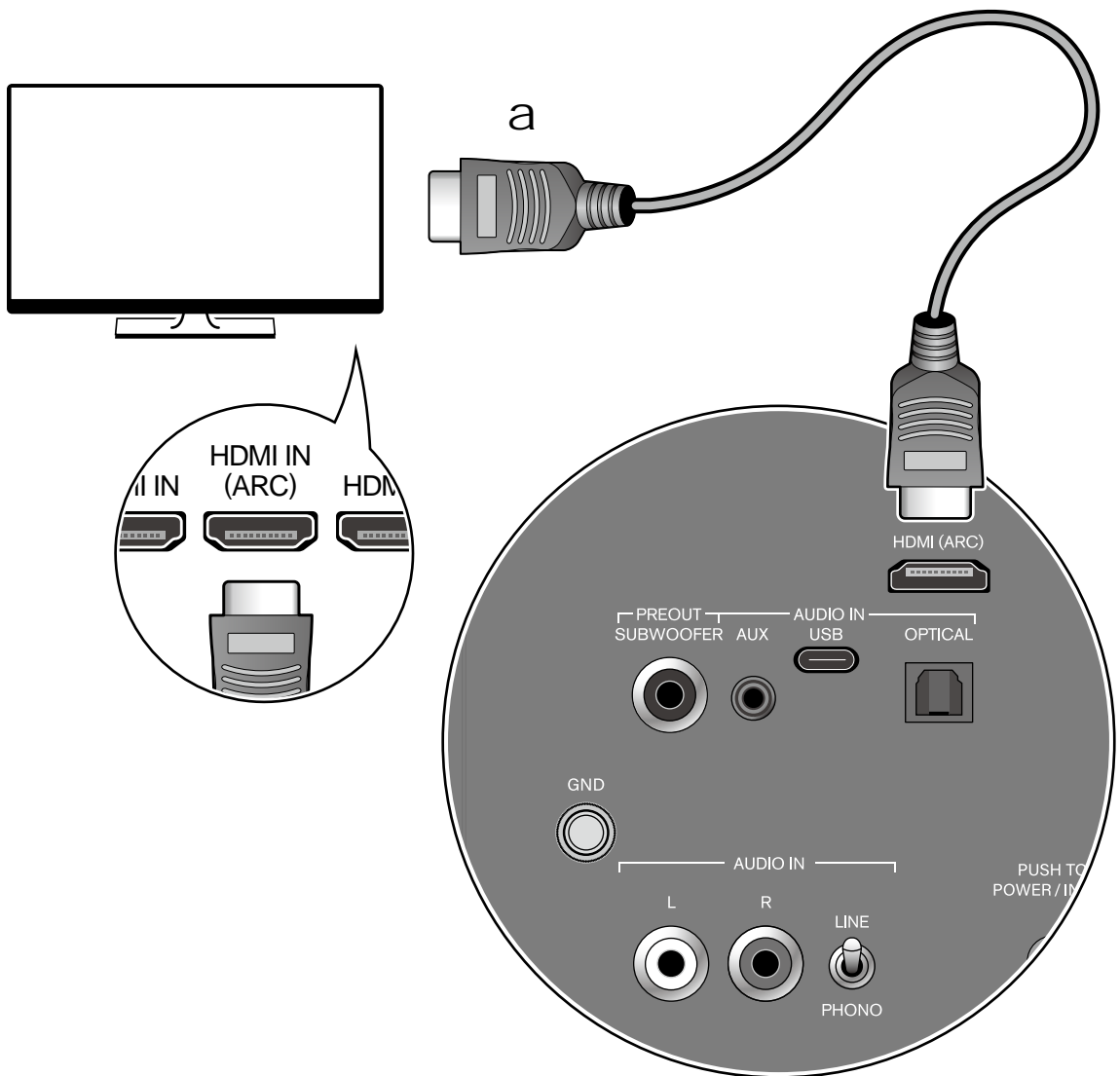

a HDMI cable

*Be sure to insert the HDMI cable all the way in.

Connection location

This unit: HDMI (ARC) terminal

TV: HDMI (ARC) terminal

Tips

The HDMI (ARC) terminal of this unit supports 2-ch PCM signals only. Set the digital audio output setting of the TV to "PCM".

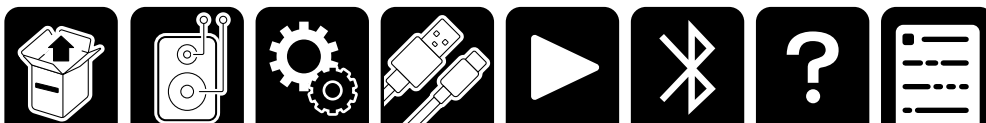

Connecting an ARC-unsupported TV

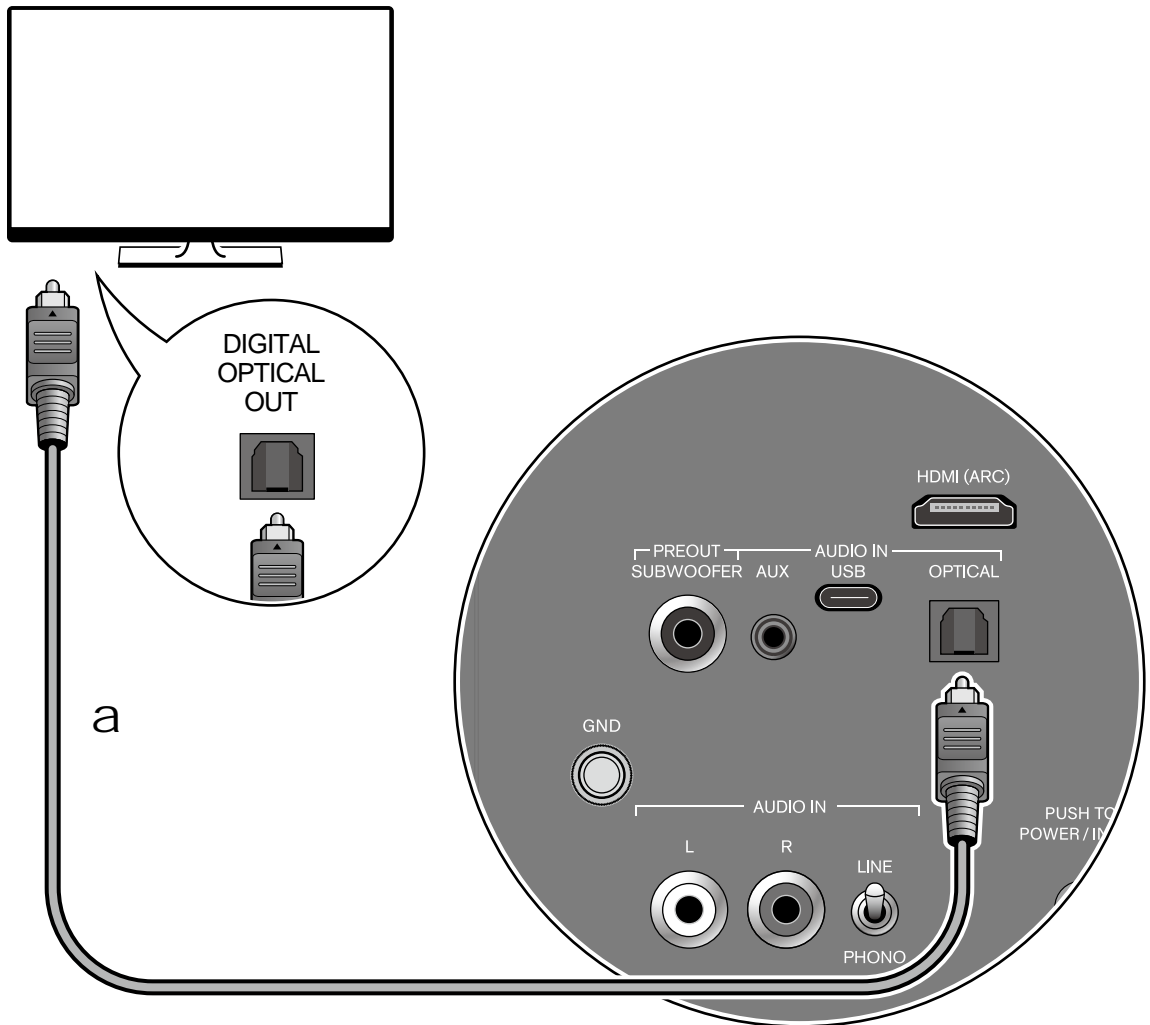

a Digital optical cable

Connection location

This unit: AUDIO IN OPTICAL terminal
TV: Optical digital output terminal

Tips

The AUDIO IN OPTICAL terminal of this unit supports 2-ch PCM signals only. Set the digital audio output setting of the TV to "PCM".

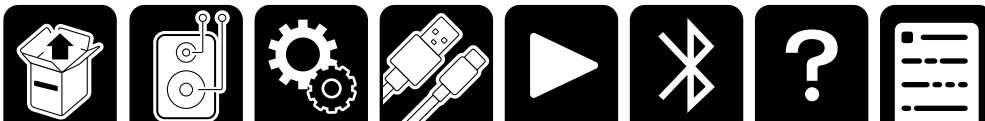

Connecting a Turntable

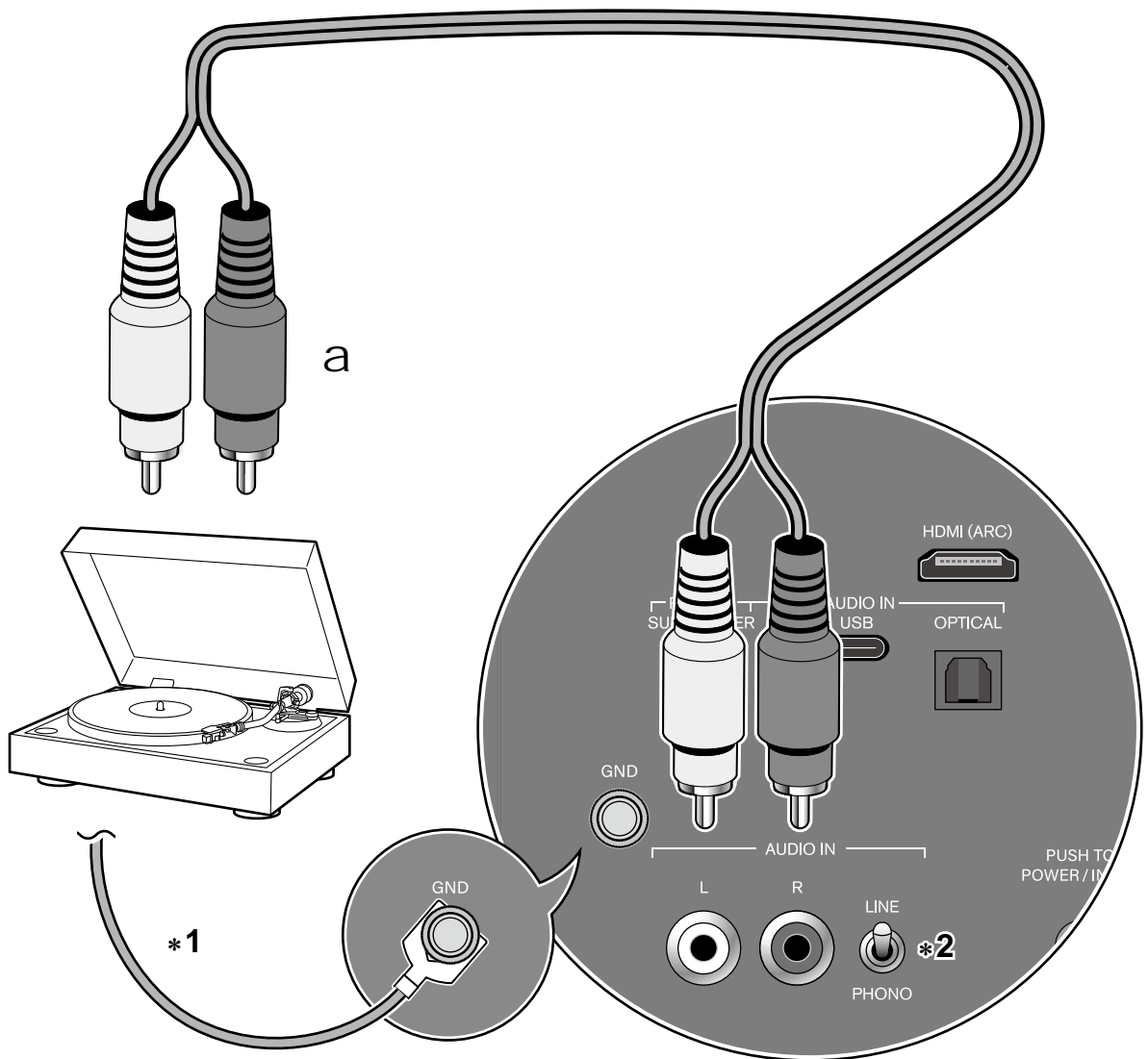

a Analog audio cable

Connection location

This unit: AUDIO IN LR terminals (RCA stereo terminals)

*1 When the turntable has a ground wire, connect it to the GND terminal.

*2 When connecting a turntable that does not have a built-in phono equalizer, set the LINE/PHONO selector switch to "PHONO".

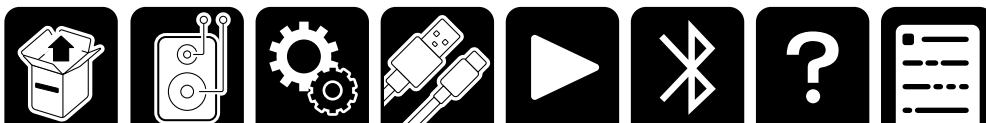

Connecting Devices Using a Stereo Mini Plug Cable

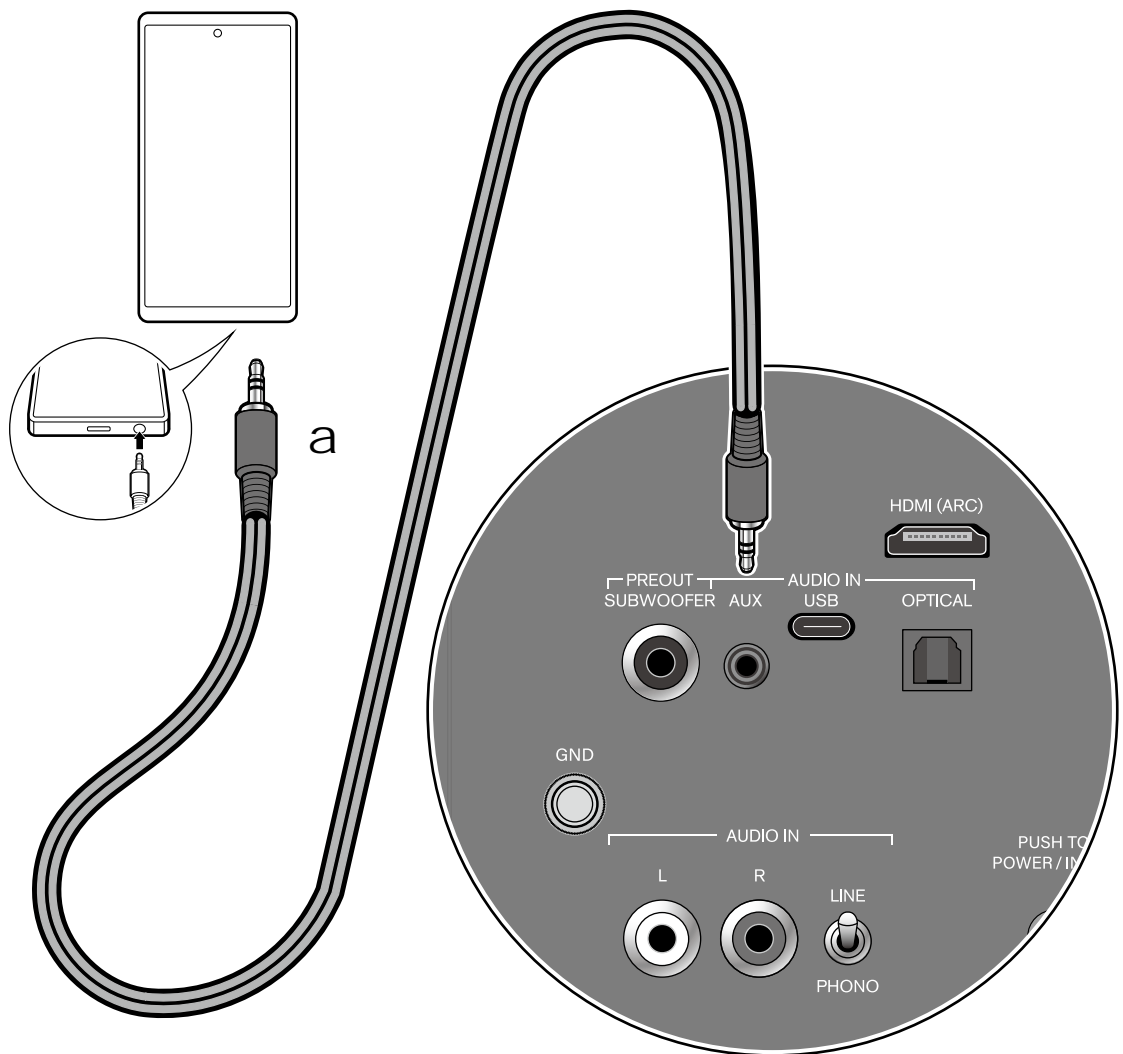

a Stereo mini plug cable

*Use a stereo mini plug cable with no resistance.

Connection location

This unit: AUDIO IN AUX terminal ($\phi 3.5\text{mm}$ stereo mini plug terminal)

External devices: Headphone terminals of smartphone, PC, digital audio player, etc.

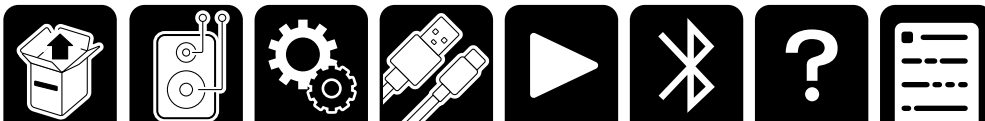

Connecting a Subwoofer

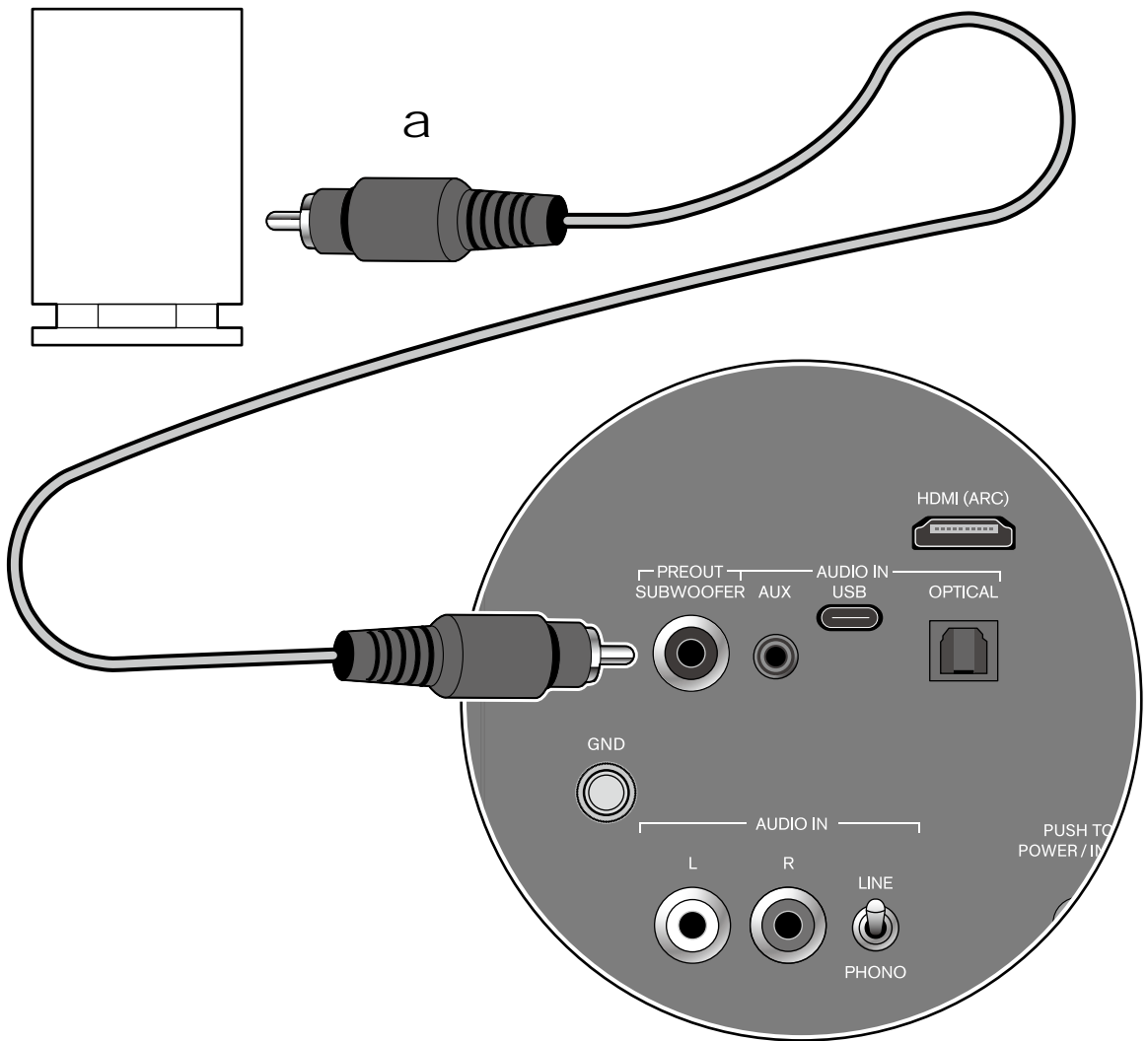

a Subwoofer cable

Connection location

This unit: PREOUT SUBWOOFER terminal (RCA monaural terminal)

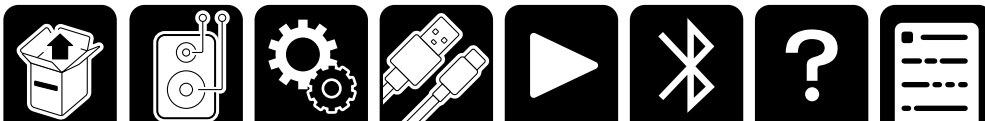

Playback

Basic Operations

■ On/Standby

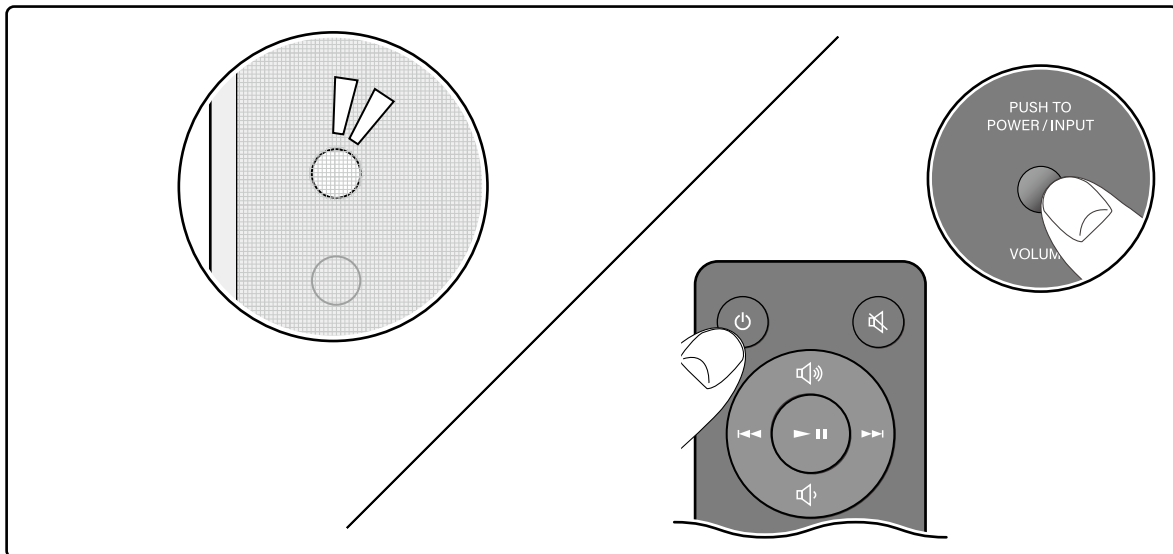

When operating with the remote controller

Press the ON/STANDBY button.

When operating with the main unit

On : Press the POWER/INPUT switch.

Standby : Press and hold the POWER/INPUT switch for three seconds.

Tips

When no signal is detected for 15 minutes or longer, the unit automatically enters the standby mode.

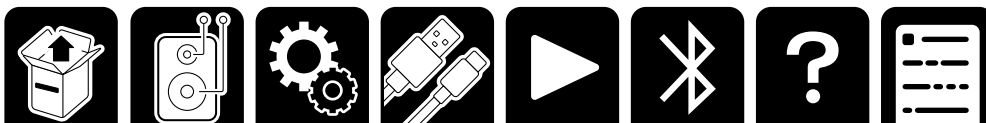

■ Switching the input source

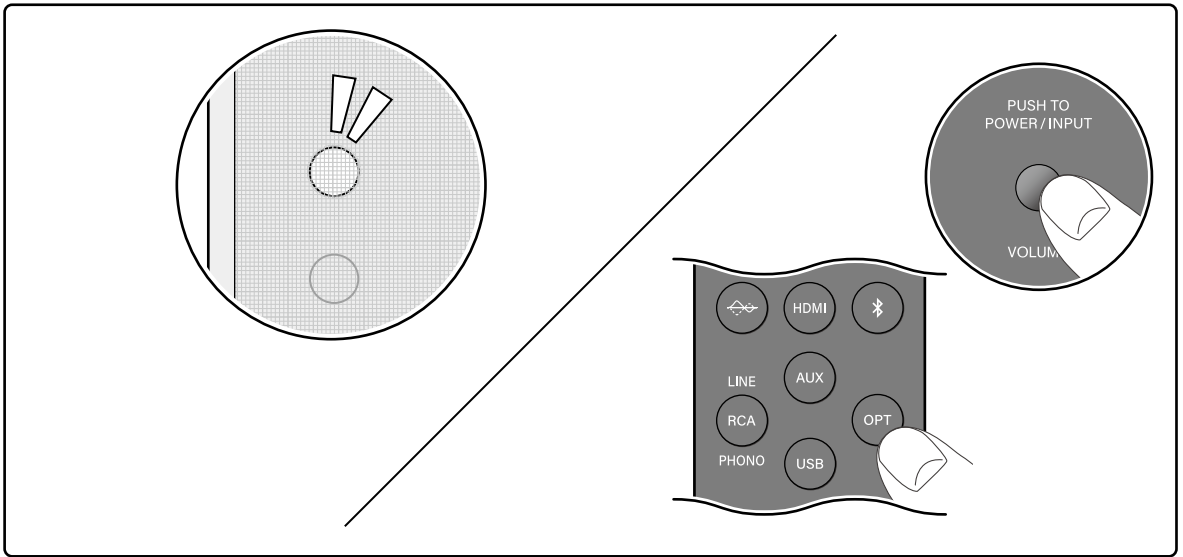

When operating with the remote controller

Press any of the input selector buttons.

When operating with the main unit

Press the POWER/INPUT switch repeatedly.

The color of the LED Source Indicator changes depending on the selected input source.

BLUETOOTH	: Blue
HDMI	: Green
USB	: White
AUX	: Amber
OPTICAL	: Yellow
RCA	: Pink

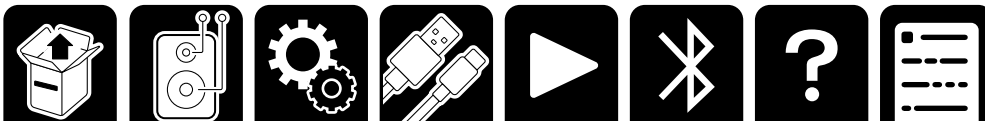

■ Adjusting the volume

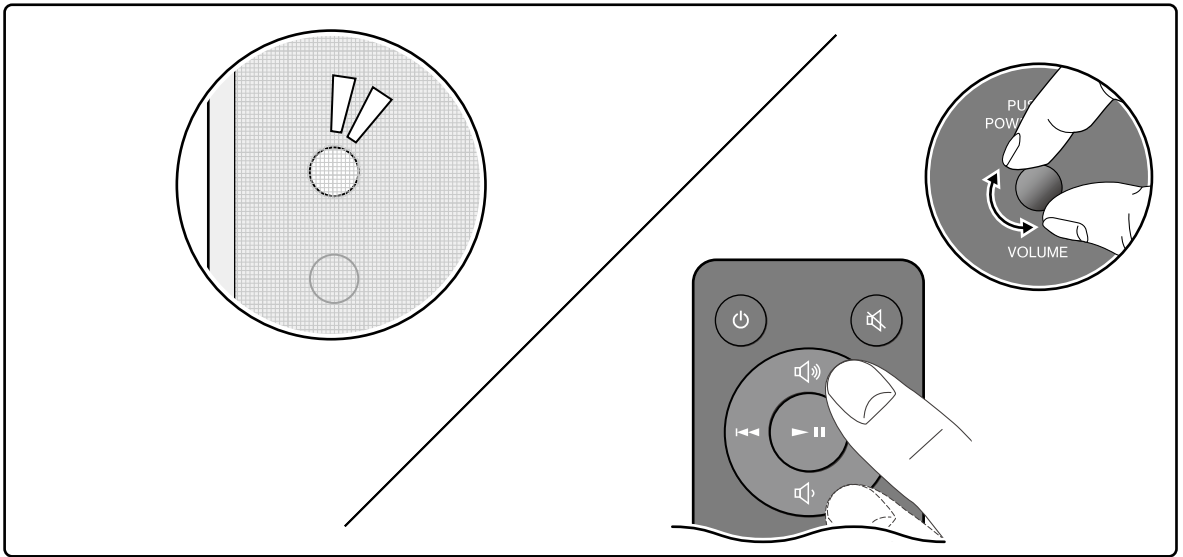

When operating with the remote controller

Press the Volume UP/DOWN buttons.

When operating with the main unit

Turn the VOLUME dial.

■ Mute

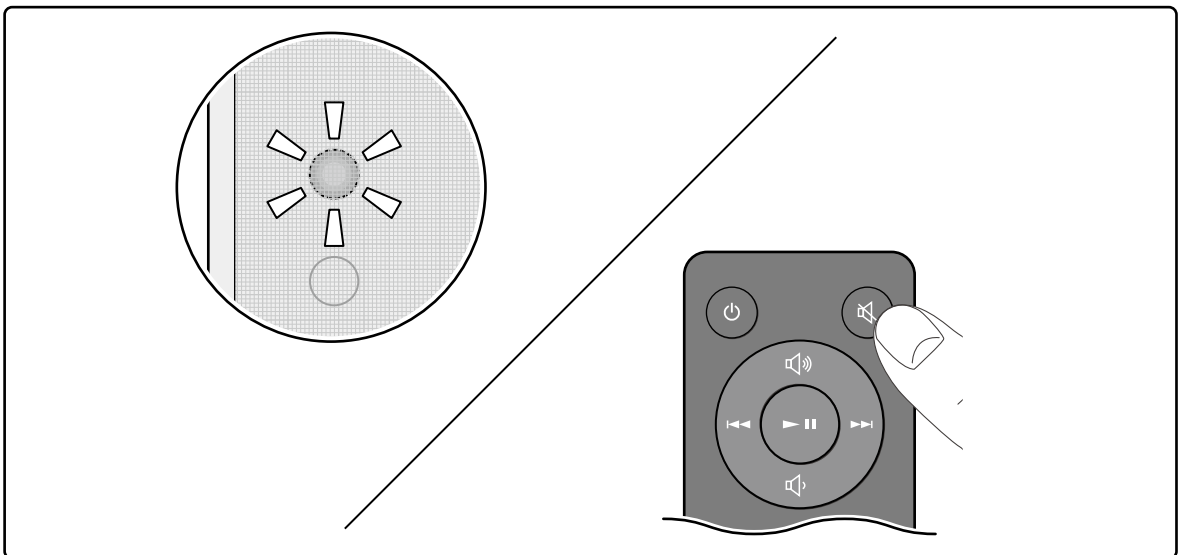

Press the Mute button.

In the mute state, the LED Source Indicator blinks in red.

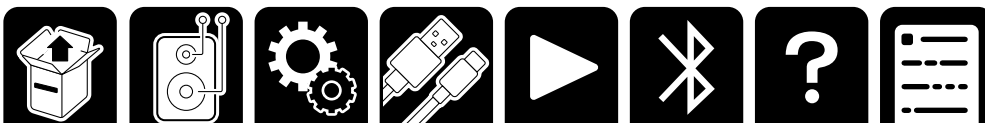

Advanced Operations

■ Setting the flat sound mode to On/Off

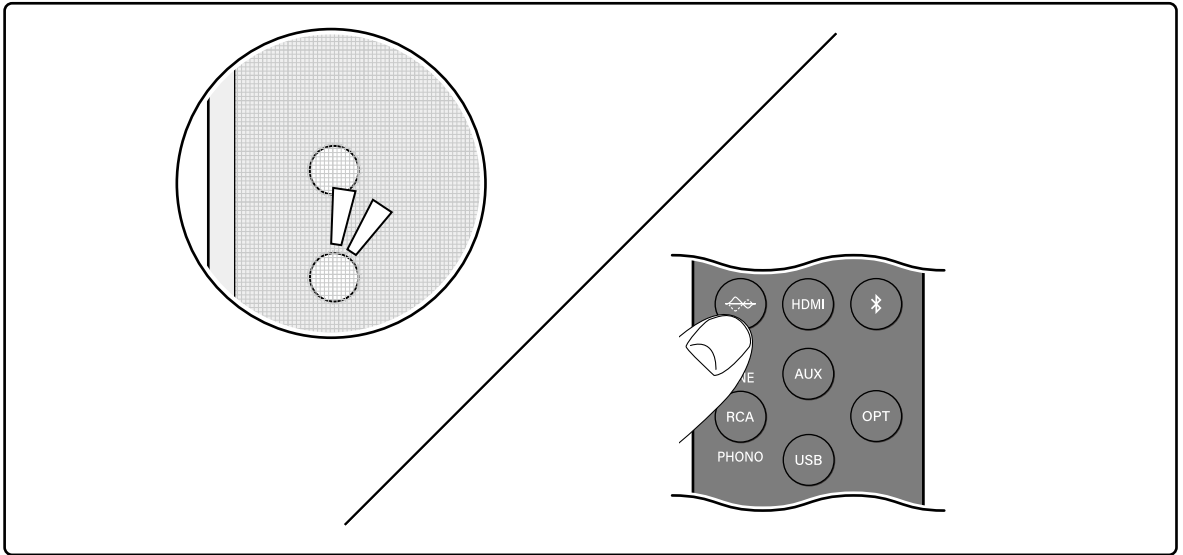

Off (default) : Bass and treble are enhanced to reproduce sound with inflection.
On : Flat sound is reproduced without enhancing bass and treble.

■ Switching between right and left

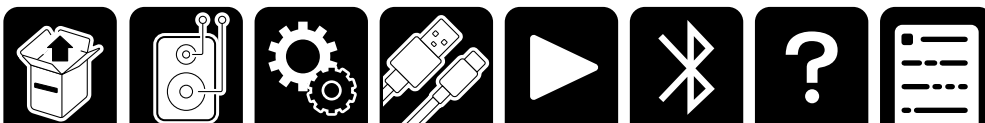
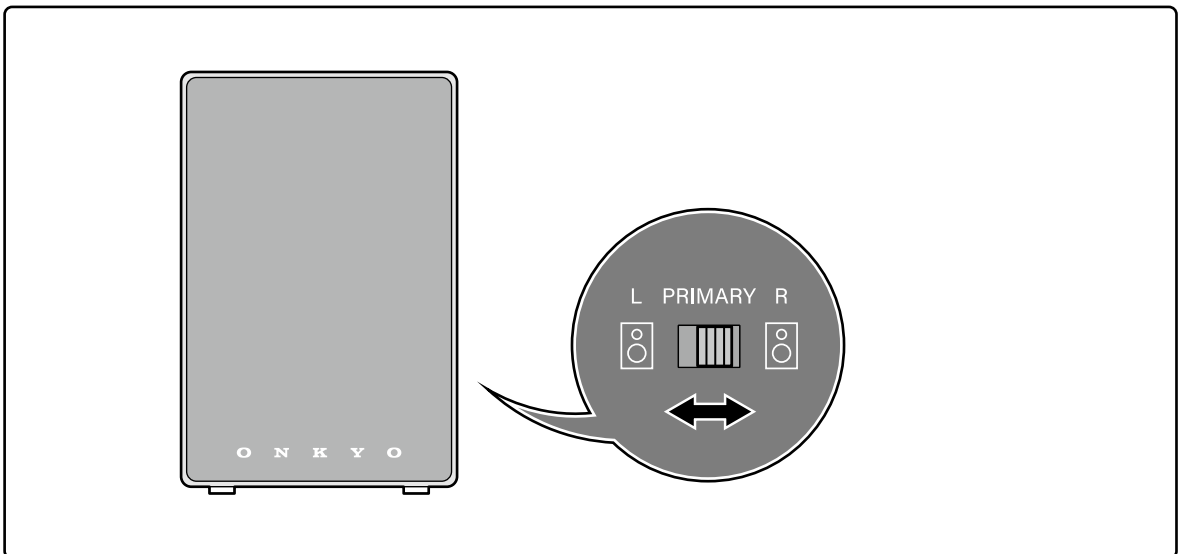

BLUETOOTH® Playback

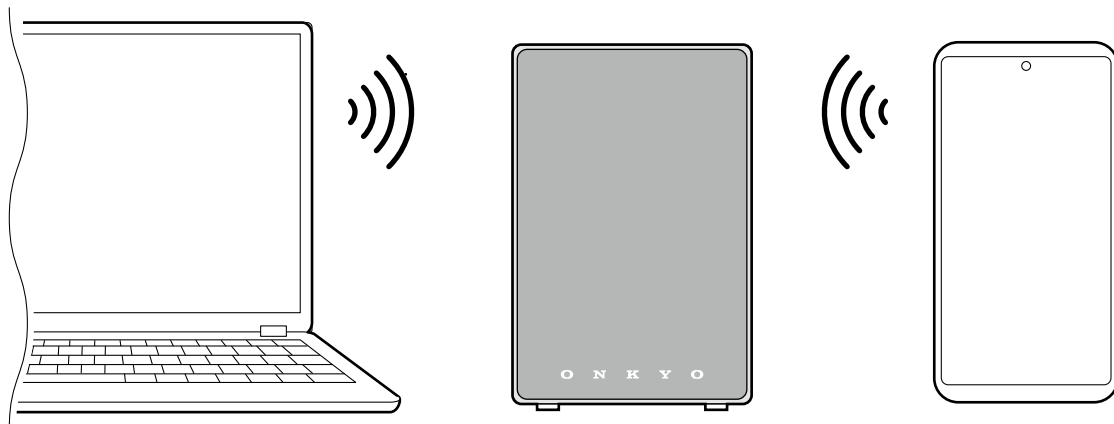

Pairing

1. Press the ON/STANDBY button to turn on the unit.

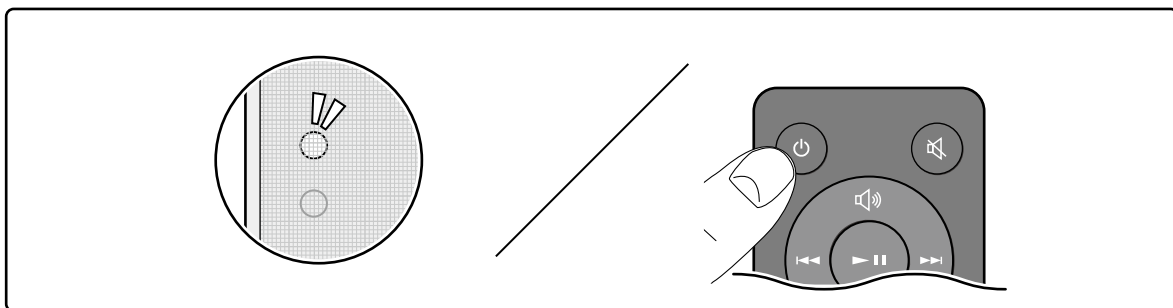

2. Press the BLUETOOTH button.

The LED Source Indicator blinks in blue, which shows the unit has entered the pairing standby mode.

- When a BLUETOOTH-supported device has already been connected, cancel the connection, or press and hold the BLUETOOTH button of the remote controller for three seconds. Then the unit enters the pairing standby mode again.

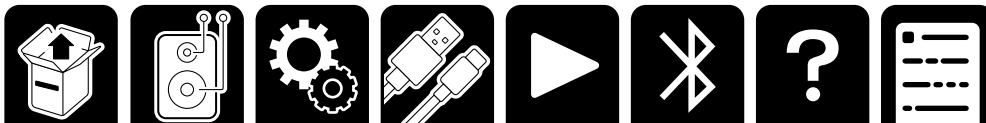
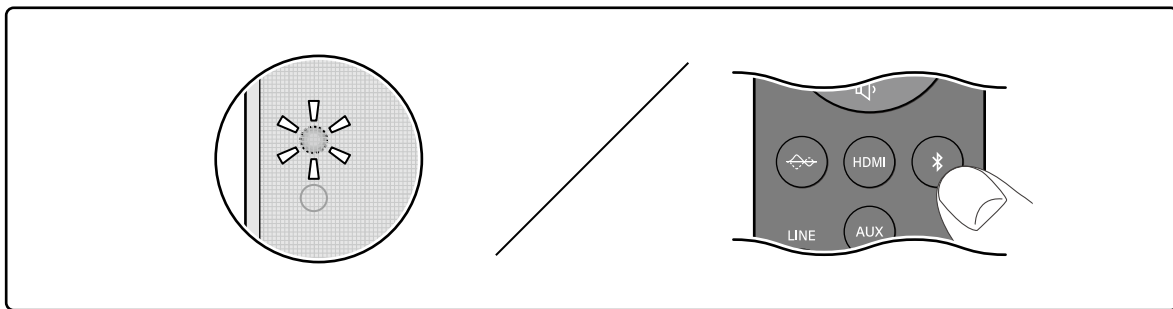

3. Turn on the BLUETOOTH function of the BLUETOOTH-supported device.

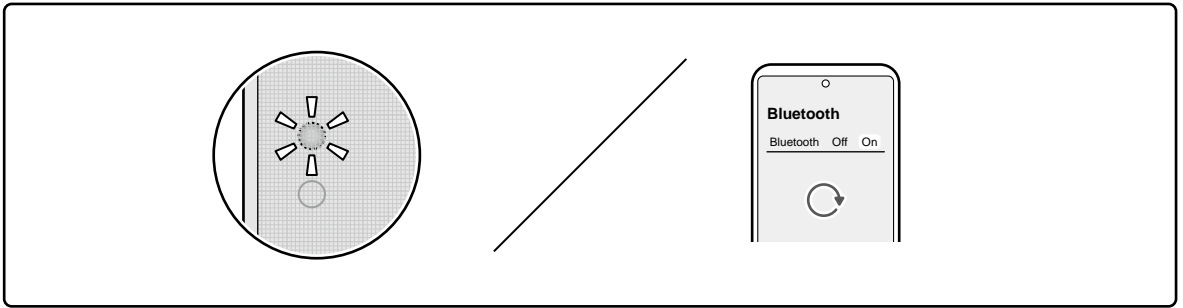

4. Operate the BLUETOOTH-supported device, and select this unit.

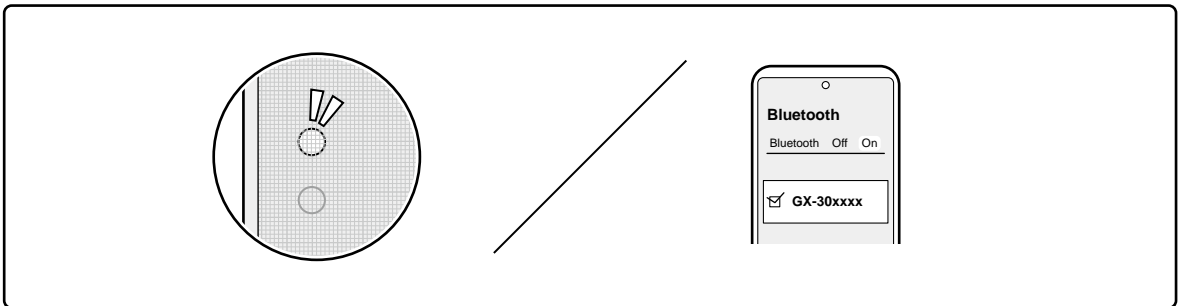

- When connecting multiple BLUETOOTH-supported devices, cancel the current connection, or press and hold the BLUETOOTH button of the remote controller for three seconds to let the unit enter the pairing standby mode. Then turn on the BLUETOOTH function of the next device.
- This unit can store the pairing information of up to 8 paired devices.

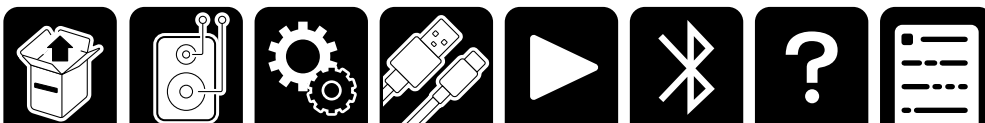

Playing Back

1. Press the ON/STANDBY button to turn on the unit.

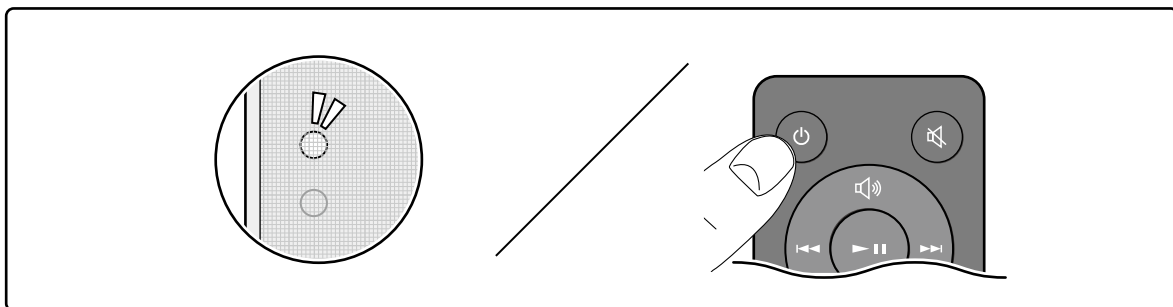

2. Press the BLUETOOTH button.

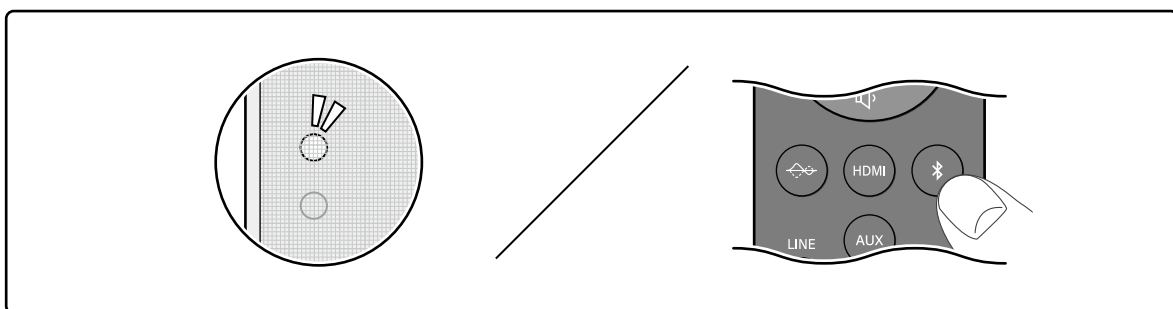

3. Operate the BLUETOOTH-supported device, and play music.

Tips

- The unit automatically turns on by operating the BLUETOOTH-supported device in standby mode to play music, etc.
- When no signal is detected for 15 minutes or longer, the unit automatically enters the standby mode.

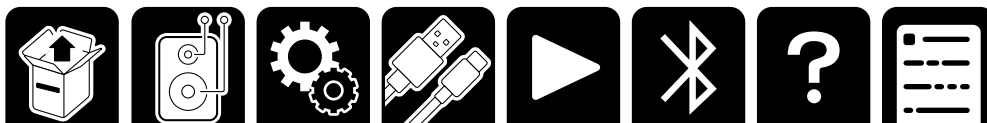

Troubleshooting

❑ Resetting the unit

Turn on the unit. While pressing down the POWER/INPUT switch on the rear panel, press and hold the Mute button on the remote controller.

The LED Source Indicator turns off, and turns on again. Then resetting is complete.

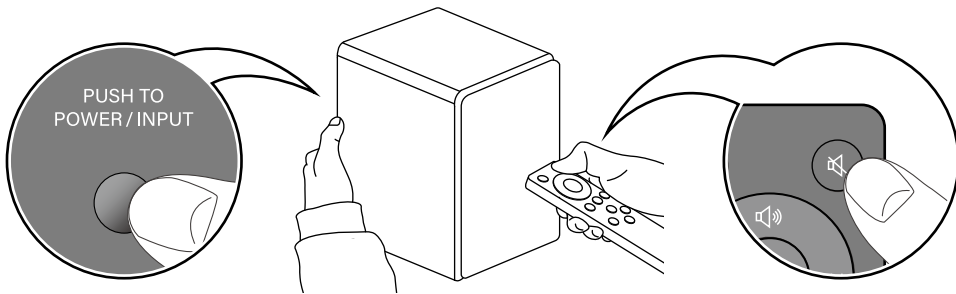

❑ Failure judgment: The LED Source Indicator lights up in red, and the unit does not turn on.

The protection circuit may be functioning.

According to the following procedure, restart the unit, and reconnect the cable.

1. Remove the AC adapter from the unit, and wait at least 10 minutes.
2. Remove the speaker cable connecting the right and left speakers, and reconnect it.
3. Reconnect the AC adapter.
4. Press the ON/STANDBY button, and check if the unit turns on.

When the unit does not turn on or the LED lights up in red again, the unit may be malfunctioning.

❑ Failure judgment: No sound is reproduced from the right or left speaker.

According to the following procedure, check whether the state of no sound is caused by this unit or the external device.

1. Turn off the unit, and set the L/R selector switch on the rear panel to L (or R).
2. Turn on the unit, and play the connected external device. Then check if the sound is reproduced.

– **No sound is reproduced from the speaker even after the switch is switched.**

The unit may be malfunctioning.

– **When the switch is switched, the sound is reproduced from the speaker that has reproduced no sound, and no sound is reproduced from the speaker that has reproduced the sound.**

When the external device has been connected to this unit with an analog cable, contact failure or disconnection of the cable may have occurred. Reconnect the cable or replace the cable with another one to see how it works.

When the external device has been connected to this unit with a digital cable, check the audio output setting of the external device.

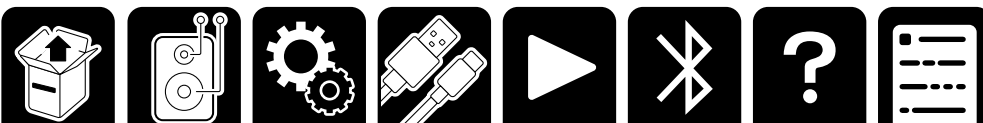

❑ Failure judgment: Pairing with a BLUETOOTH-supported device cannot be established.

According to the following procedure, delete the information of the BLUETOOTH-supported device, and perform pairing again.

1. Turn on the unit, and press and hold the BLUETOOTH button on the remote controller at least 10 seconds. Pressing and holding the button for 10 seconds or longer will delete the information of the BLUETOOTH-supported device stored in the unit.
2. Open the setting screen of the BLUETOOTH-supported device (smartphone, PC, etc.), and delete the information of this unit (device name) that has been registered.
*For more information, refer to the instruction manual of the BLUETOOTH-supported device.

Repairing

1. Turn on the unit, and press the BLUETOOTH button on the remote controller.
2. Confirm that the LED Source Indicator blinks in blue. Then operate the BLUETOOTH-supported device, and perform pairing again.
3. When the pairing is successful and the LED Source Indicator lights up, play music, etc. to check if the sound is reproduced.

❑ Failure judgment: No sound is reproduced from PC.

When the PC is connected using a USB cable

According to the following procedure, confirm the PC settings.

1. While this unit is connected, right-click the speaker symbol at the bottom right of the PC screen, and select "Sound setting".
2. Select "Output" - "Choose where to play sound" and set this unit.

If no sound is reproduced even after the setting is complete, or if this unit is not displayed on the setting screen, change the connection location of the USB terminal, and see how it works.

If no sound is reproduced even after the connection location is changed, the unit may be malfunctioning.

❑ Failure judgment: No sound is reproduced from TV.

When the TV is connected using an HDMI cable

- Check if the HDMI terminal of the TV supports the ARC function.
A supporting HDMI terminal indicates "ARC" on it.
- Check if the ARC function is turned on in the TV settings.
Some TVs require operation to switch audio output between from TV and from audio equipment.

When the TV is connected using an optical digital cable

- Check if the digital audio output setting of the TV is set to "PCM".
This unit supports PCM signals. It does not support Dolby Digital or AAC.

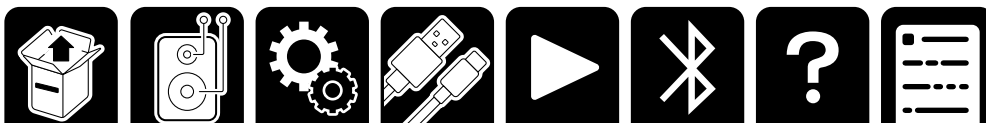

General Specifications

■Type

PRIMARY SPEAKER: Built-in amplifier, 2-way bass reflex type, detachable speaker grill

SECONDARY SPEAKER: 2-way bass reflex type, detachable speaker grill

■Speakers used

Woofer : 4inch(101.60mm) , Tweeter : 3/4inch (19mm)

■Amplifier configurations

Bi-Amplifier

■Power Output

2 ch × 25 W(HF:8W + LF:17W) at 8 ohms, HF:10 kHz, 2 ch driven of 1% THD, LF:100 Hz, 2 ch driven of 1% THD

■Input terminals

Analog

- AUX terminal (φ3.5mm stereo mini plug) ×1
- RCA stereo terminal (LINE/PHONO) ×1

Digital

- Optical digital terminal (PCM 2ch/32kHz, 44.1kHz, 48kHz) ×1
- USB Type-C terminal ×1
- HDMI (ARC) terminal ×1

■Output terminal

HDMI ARC terminal

SUBWOOFER terminal

■Other terminals

Speaker terminal

GND terminal

■BLUETOOTH Section

Communication system

- Bluetooth Specification version 5.3 + dual mode

Frequency band

- 2.4GHz (2.402-2.480GHz)

Modulation method

- FHSS (Frequency Hopping Spread Spectrum)

Compatible BLUETOOTH profiles

- A2DP 1.3.2, AVRCP 1.6.2, HFP1.8, HSP 1.2, SPP 1.2

Supported Codecs

- SBC

Transmission range (A2DP)

- 20 Hz - 20 kHz (Sampling frequency 44.1kHz)

Maximum communication range

- Line of sight approx. 15 m(*)

(*)The actual range will vary depending on factors such as obstacles between devices, magnetic fields around a microwave oven, static electricity, cordless phone, reception sensitivity, antenna's performance, operating system, software application, etc.

Maximum radio-frequency power transmitted in the frequency band(s)

- 2400 MHz - 2483.5 MHz (20 dBm (e.i.r.p))

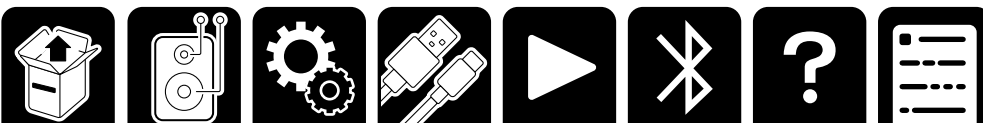

■USB Section

USB Ver.2.0, Type-C

Power Supply

- 5V/1A

Supported Formats

- FAT,FAT32,NTFS

Audio Format

- WAV, MP3(32-320kbps/32,44.1,48kHz/VBR)

■HDMI Section

ARC compatible audio format: PCM

■General

Power Supply

- AC 100 - 240 V, 50/60 Hz

Power Consumption

- 10 W

Standby mode

- BLUETOOTH : 0.3 W
- HDMI : 0.3 W
- USB : 0.3 W
- AUX : 0.3 W
- OPTICAL : 0.3 W
- RCA : 0.3 W

*In this mode, when there is no signal output, the idle power consumption is 0.3 W after 15 minutes.

Dimensions (W × H × D)

- PRIMARY SPEAKER : 146 mm × 224 mm × 188 mm (including speaker grilles and protrusions on the back)
- SECONDARY SPEAKER : 146 mm × 224 mm × 180 mm (including speaker grilles and protrusions on the back)

Weight

- PRIMARY SPEAKER : 2.7 kg (including speaker grill)
- SECONDARY SPEAKER : 2.4 kg (including speaker grill)

■License and Trademark



The terms HDMI and HDMI High-Definition Multimedia Interface, and the HDMI Logo are trademarks or registered trademarks of HDMI Licensing Administrator, Inc. in the United States and other countries.



The BLUETOOTH® word mark and logos are registered trademarks owned by BLUETOOTH SIG, Inc.

All other trademarks are the property of their respective owners.

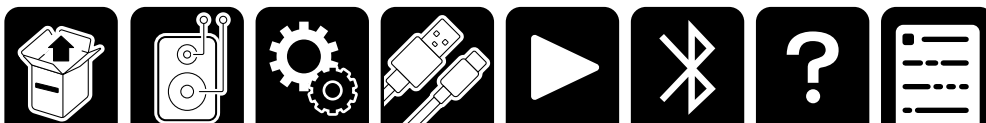

O N K Y O

SN 29404187_EN

© Copyright 2025 Premium Audio Company Technology Center K.K. All rights reserved.

© Copyright 2025 Premium Audio Company Technology Center K.K. Tous droits de reproduction et de traduction réservés.

O2501-0